

Multi-objective optimization design of plate-fin heat sinks using an Evolutionary Algorithm Based On Decomposition

Maziyar Nourozi², Ehsanolah Assareh^{1,2*}, Abbas Taghipoor², Tahereh pirhoushyaran³, Reza Poultangari^{1,2}

¹Materials and Energy Research Center, Dezful Branch, Islamic Azad University, Dezful, Iran

²Department of Mechanical Engineering, Dezful Branch, Islamic Azad University, Dezful, Iran

³Department of Chemical Engineering, Dezful Branch, Islamic Azad University, Dezful, Iran

Received: December 2018

Accepted: February 2019

Abstract

Heat sink is part of a thermal convertor that cools the convertor by dissipation of heat into the surrounding air. In order to obtain the optimal design of any heat sink, the rate of entropy generation must be minimized. However, reduced generation of entropy is accompanied by an increase in the cost, and hence these two contradictory objectives must be simultaneously optimized. In the present study, Multi-objective Optimization Evolutionary Algorithm Based On Decomposition (MOEA/D) has been used for optimization. The complete mathematical model governing the heat sink has been investigated and its basic experimental and computational data have been derived. According to the results, all the four considered parameters in the optimization had a relatively linear relation to the cost, but the number of fins and the air flow speed had a more significant effect on the entropy generation rate. In sum, when the cost is considered, a better evaluation of the results is obtained. With regard to the optimization process in this work, the objective functions of price and generation of entropy have linearly entered the numerical equations. The values for the distance and the length of the fins have been obtained using RSM and decision-maker methods. Besides, the optimized values of the objective functions have been expressed for each type of the flows related to the heat sink.

*corresponding author: assareh@iaud.ac.ir

Keywords: Plate Fin Heat Sink, Modeling, Optimization, MOEA/D

1- Introduction

Nowadays, with the technological advances in the field of central processing units (CPUs), the heat sinks are needed extensively. CPU size is decreasing but its capabilities are increasing, and therefore heat generation inside this tiny piece increases. One of the simplest and most effective methods for cooling the CPU pieces is to use the plate fin heat sinks. The mechanism of action for a heat sink is as follows: heat sink is attached to the hot

surface and since it is made of metal, it causes heat to move from the hot surface toward the outside. Heat sinks are usually made of aluminum or copper or an alloy of these two metals. Inside this system, air coolant fans exist which can dissipate the generated air in the piece. Otherwise, the piece would be overheated and seriously damaged. Different factors inside this system can be regarded as the main variable for optimization. In a study by Bejan [1, 2], the rate of entropy generation was considered the main variable and entropy generation

minimization was proposed as an effective way for optimal design of the fins. In this work, the design of the plate fin heat sinks is investigated. This study aims to offer the optimal state and discusses the conditions for improving the main values. Ryun [3], Bar-Cohen [4], and Shih [5] in the years 2002-2004 did research on single objective optimization in heat sink design. Subsequently, despite the better results of multi-objective optimization in engineering problems, different approaches to this algorithm, which were mostly approximate models, were utilized for the optimal design of the heat sinks. In this regard, Park and Moon [9] used the response surface methodology (RSM) and Chang and Chang [6] in 2006 used a method called orthogonal arrays. In some works, a combination of several approaches was employed for multi-objective optimization. These are called hybrid methods. In 2008, Srisomporn et al. [7] combined two approaches of SPEA and RSM for the optimal design of a vertical plate fin heat sink. In 2010, this group [8] also used another method called population based incremental learning (PBIL) model for the same purpose. Under the optimized conditions, parameters such as wind speed is placed in the set {2,3,4,5,6} m/s, the width is $W=63\text{mm}$, and the length equals $L=80\text{mm}$. The research results showed that in the best state, the fins must be placed directly and with variable heights inside the system. Chen et al. [9] used a directed genetic algorithm to optimize a plate fin heat sink. They simultaneously considered the entropy generation minimization and heat sink materials cost minimization. Generally, some properties of a heat sink that affect its performance are: contact area of the heat sink, temperature difference between hot surface and environment, the way the heat sink is installed, etc. In analysis-based optimization algorithm, instead of direct solution from the summation aggregation of the objective functions, the main problem has been subdivided into a number of sub-problems, which are then solved simultaneously. In this problem, the objective functions are the cost and entropy generation. The dependent parameters are flow velocity and the number of fins.

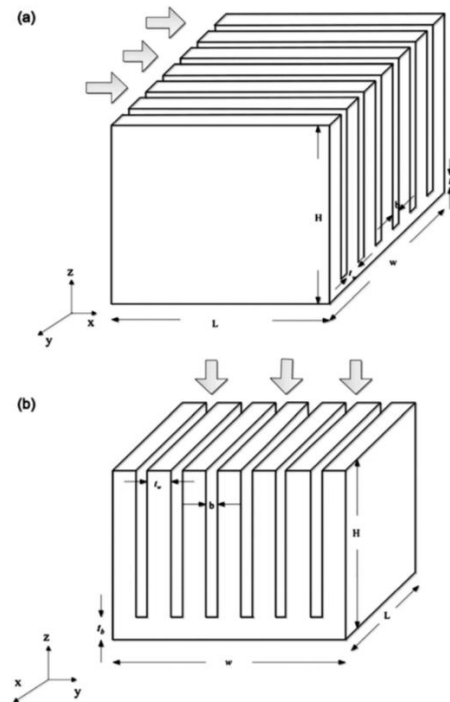

Figure 1. A schema of plate fin heat sink along with the internal flow coolant of (a) flow-through system and (b) impingement-flow system

2- Multi-objective optimization algorithm of MOEA/D

When working with a real system, a number of opposing objectives might exist which also need to be satisfied simultaneously. In many studies, the multi-objective evolutionary algorithm based on decomposition (MOEA/D) has been used to get the system to one of the optimization states. In 2007, Zhang and Li [11] first proposed the analysis algorithm (MOEA/D), which was then used by many other researchers.

3- Solution method

3-1 Governing equations

The price function is modeled as follows:

$$C_{mat} = \rho_m(w \times L \times t_b + N \times H \times b \times L) \times Price \quad (1)$$

Where ρ_m is the density of the materials in kg/m^3 . N is the number of fins, L shows the length in m, and t_b is the fin base. $Price$ is the price of aluminum, b is the distance

between two fins, and w shows the width of the plate-fin. For optimization of the heat sink, two objective functions under MOEA/D methodology are formulated as follows:

$$\text{minimize } F(x) = (\dot{S}(x), C_{mat}(x)) \quad (2)$$

$$\text{subject to } x \in R^m \quad (3)$$

These two objective functions must be simultaneously minimized and are also required to satisfy the following limitations:

$$g_1 = 0.001 - \left(\frac{w - t_w}{N - 1} - t_w \right) \leq 0 \quad (4)$$

$$g_2 = \left(\frac{w - t_w}{N - 1} - t_w \right) - 0.005 \leq 0 \quad (5)$$

Limitations g_1 and g_2 show that the fin gap must be between 0.001 and 0.005. The limitations below must also be applied:

$$g_3 = 0.001 - \frac{H}{((w - t_w)/(N - 1) - t_w)} \leq 0 \quad (6)$$

$$g_4 = \frac{H}{((w - t_w)/(N - 1) - t_w)} - 19.4 \leq 0 \quad (7)$$

Limitations g_3 and g_4 show that the ratio of the height to the thickness of the fins must be in the range from 0.001 to 19.4. In addition to the aforementioned limitations, some design parameters need to be considered as follows:

$$2 \leq N \leq 40$$

$$0.025 \leq H \leq 0.14$$

$$2 \times 10^{-4} \leq b \leq 2.5 \times 10^{-4}$$

$$0.5 \leq V_f \leq 2$$

$$N \times b \leq 0.05$$

By performing thermal analysis for the plate fin heat sink under the convective flow, the entropy generation is obtained as follows:

$$\dot{S}_{gen} = \left(\frac{\dot{Q}}{T_{amb}} \right)^2 R_{sink} + \frac{F_d V_f}{T_{amb}} \quad (8)$$

In this relation, \dot{Q} shows heat generation inside the system; T_{amb} is the surrounding air temperature; F_d is air resistance between the fins; and V_f shows air resistance between the inlet air velocity. Entropy generation depends on the total heat resistance (R_{sink}), which can be defined as follows:

$$R_{sink} = \frac{1}{(N/R_{fin}) + h_{eff}(N - 1)bL} + \frac{t_b}{kLw} \quad (9)$$

In the above equation, h_{eff} is heat transfer coefficient in W/m^2k and R_{fin} is the thermal resistance of each fin in K/w . The thermal resistance of any fin can be expressed as follows:

$$R_{fin} = \frac{1}{\sqrt{h_{eff} P k A_c} \tanh(mh)} \quad (10)$$

Where m is obtained by the relation below:

$$m = \sqrt{h_{eff} P / k A_c} \quad (11)$$

In the above equation, P and A_c are perimeter and sectional area of each fin. By writing force equilibrium on the heat sink, F_d is obtained:

$$\frac{F_d}{(1/2)\rho V_{ch}^2} = f_{app} N(2HL + bL) + k_c(Hw) \quad (12)$$

$$+ k_e(Hw) \quad (13)$$

$$k_c = 0.42(1 - \sigma^2) \quad (14)$$

$$k_e = (1 - \sigma^2)^2 \quad (15)$$

$$\sigma = 1 - (nt_w/w)$$

Where V_{ch} is air velocity inside channel and f_{app} is the friction factor. Air velocity inside channel can be written as follows:

$$V_{ch} = V_f \left(1 + \frac{t_w}{b} \right) \quad (16)$$

Also, f_{app} can be obtained by the following equation:

$$f_{app} Re = \sqrt{\left(\frac{3.44}{\sqrt{L^*}} \right)^2 + (f Re)} \quad (17)$$

Where $L^* = L/(D_h Re)$. For Re and friction factor, we have:

$$fRe = 24 - 32.527 \left(\frac{b}{H}\right) + 46.721 \left(\frac{b}{H}\right)^2 - 40.829 \left(\frac{b}{H}\right)^3 + 22.954 \left(\frac{b}{H}\right)^4 - 6.089 \left(\frac{b}{H}\right)^5 \quad (18)$$

Therefore, all the variables of the objective functions are calculable based on the suggested equations. These two functions generally have four variables as N , H , b , and v_f . In order to optimize the objective functions, it is required to investigate the variations in these variables using MOEA/D method. For example, with the increase in N and H (i.e., the number and the height of the fins, respectively), entropy generation declines but the price of the materials rises. So, the variations are sometimes contradictory and need to be cared when optimization is carried out.

4- Validation

For validation, the research results of Culham [12] have been used. Under similar geometric and operational conditions, Fig. 1 shows a comparison of the results. In Fig. 1, the horizontal axis shows the number of fins while the vertical axis shows entropy generation. This diagram has two curves comparing the results of the present study with Culham's [12]. As is seen, the results of the two studies are in close agreement. With the increase in the number of fins, entropy generation first reduces and then reaches a nearly fixed value. After that, with further increases in the number of fins, entropy generation shows an increasing trend.

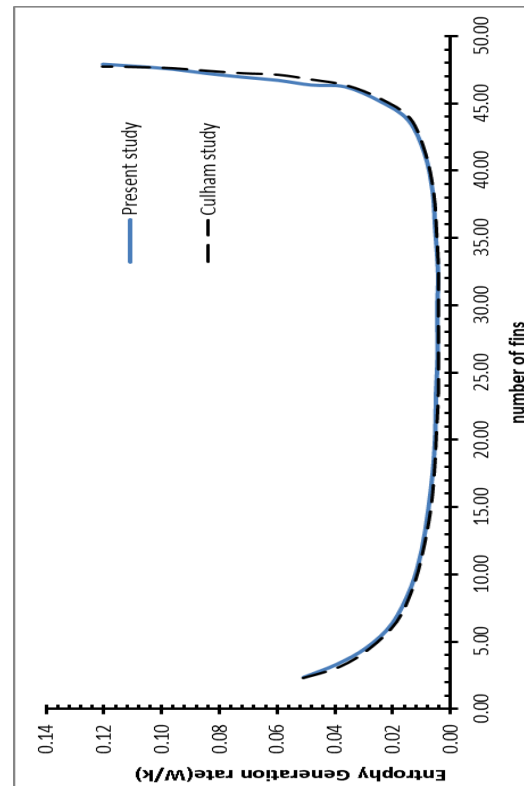

Fig. 2. Results comparison between the present study and Culham's for validation

5- Results and discussion

Regarding the functions, four variables for multi-objective optimization exist, which are the number of fins, height of fins, distance among the fins, and the velocity of the passing air flow. From the diagrams in Fig. 1, it can be realized that with the entropy generation over 0.01 W/k, the price approximately does not reduce any more. In both diagrams, most of the concentration of the obtained points is at the initial points. It is clearly observed that with a slight change in the rate of entropy generation, a considerable reduction occurs in the price. This well indicates the effect of the multi-objective optimization on the plate fin heat sink systems. Fig. 2 and Fig. 3 show the effect of the number of fins on the values of heat sink cost and entropy generation.

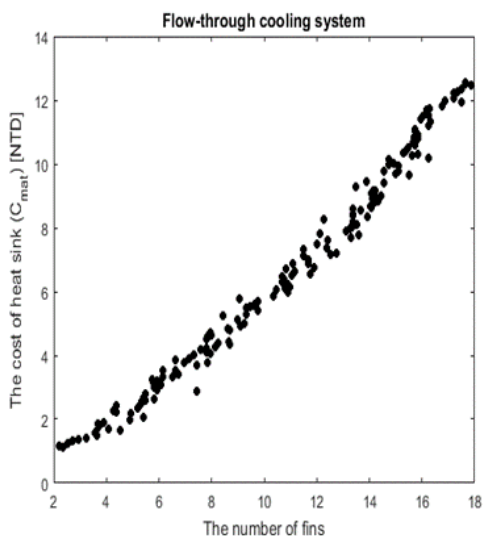

Fig. 3. Changes of materials price versus the number of fins for flow-through system in multi-objective responses

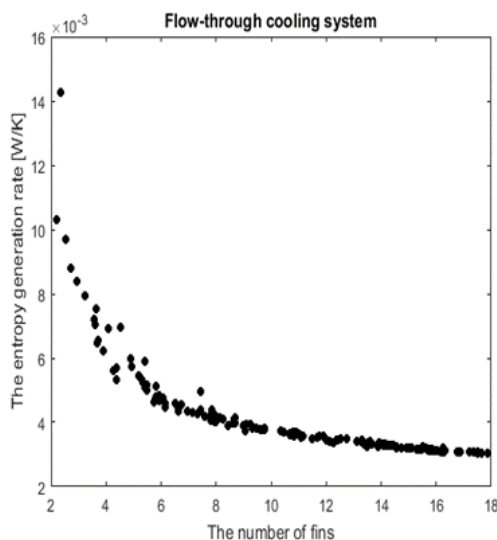

Fig. 5 Changes of entropy generation versus the number of fins for the flow-through system in multi-objective optimization responses

As this figure shows, increased number of fins is quite linearly related to the increased cost. Besides, while it first causes a considerable reduction in the rate of entropy generation, this decreasing trend subsequently lessens.

However, when the number of fins is increased to 18, entropy generation does not reduce even to below 3 W/k. This trend is well indicated in the optimization results showing that entropy has initially been considerably influenced by the number of fins. With a few reductions in the number of fins, a linear increase occurs in the cost and the rate of entropy generation considerably decreases. After that (with further decreases in the number of fins), this phenomenon is not effective any more. Analytically viewed, it can be stated that the selection of the optimal points must be about the fin numbers of 6 to 12 so that entropy generation minimization and cost control can simultaneously be achieved. The effect of air flow velocity (Fig. 4 and Fig. 5) is also similar to the effect of the number of fins. In other words, increased velocity of air flow is related to the linear increase in the costs; however, it initially causes a substantial decrease in the rate of entropy generation and then from about 0.8 m/s onwards a very smooth linear reduction in this rate is observed.

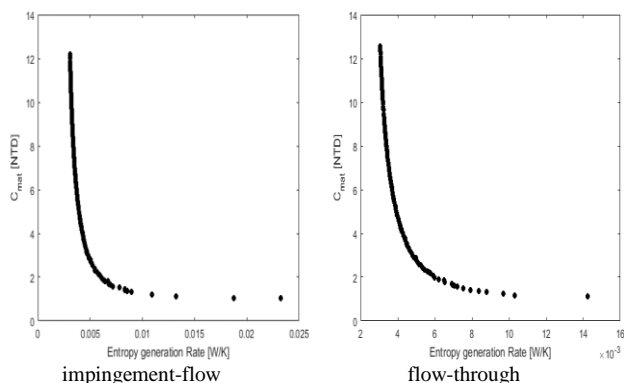

Fig. 4. Diagram obtained from MOEA/D solver for two objectives for flow-through and impingement-flow systems

When the number of fins is equal to 2, the rate of entropy generation for the flow-through system is in the range from 10 W/k to over 14 W/k with a rough average of about 12 W/k. However, when the number of fins is increased to 8, this rate reduces to less than 4 W/k (or, less than one third of its initial value).

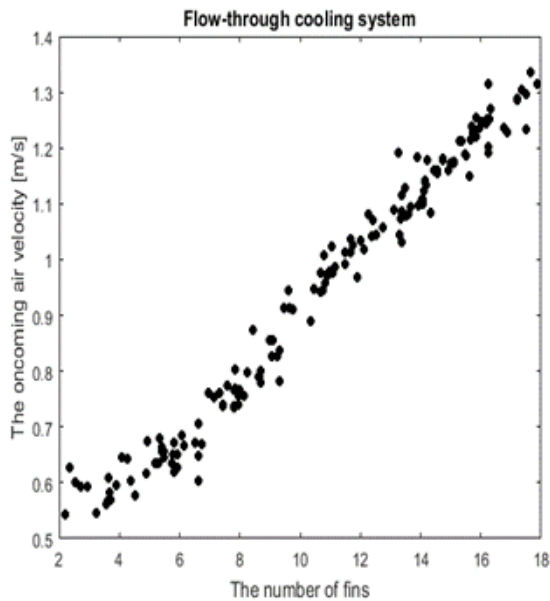

Fig. 5 changes of air flow velocity for flow-through system in optimal responses

From the diagrams in Figs. 4 and 5 and the above explanations about the number of fins, it can be stated that the velocity effect is qualitatively optimized from 0.8 m/s to 0.9 m/s. Fig. 5 also shows that under optimal conditions, air flow velocity and number of fins have an approximately linear relation to one another. The results of this problem are also obtained with respect to the other optimization methods – as shown in Figs 6 to 9. The response surface methodology, RSM, is as an experimental method that, through a proper test plan, gives an estimation of the interactions, second degree effects, and even the topical shape of the response surface under study. In this context, some objectives are in the focus of attention, among which are improving the procedure by finding optimal inputs, resolving problems and demerits from the procedure, and stabilizing it. Here, stabilization is an important concept in quality statistics which indicates the minimization of the effects of secondary or non-control (turbulent) variables. Using response surface methodology without having sufficient information about the procedure and its influencing variables might be misleading. It is more common to properly investigate the procedure under study before conducting the steps of the RSM method. Besides, it is first required to use a screening test plan for identification of the effects of the inputs on the considered procedure. Fig. 6 shows the RSM results with respect to the values of the price function and entropy generation function. In LINMAP method, it is assumed

that the decision-maker makes a choice (from the two assumed choices) which is closest to the ideal, and the distance from the ideal is considered as weighted Euclidian distance (d_i) on choice A_i . Weights of W_j are used to convert the existing scales into similar scales, which also show the degree of importance of the indexes. TOPSIS method, which was proposed by Huang and Yung in 1981, is one of the best multi-criteria decision-making models. This technique is based on the idea that the selected choice must have the least distance to the ideal positive solution (the best possible state) and the most distance to the ideal negative solution (the worst possible state). AHP method, after normalization of the objective functions, uses the average of their values and the maximum value of this average is selected as the optimal choice.

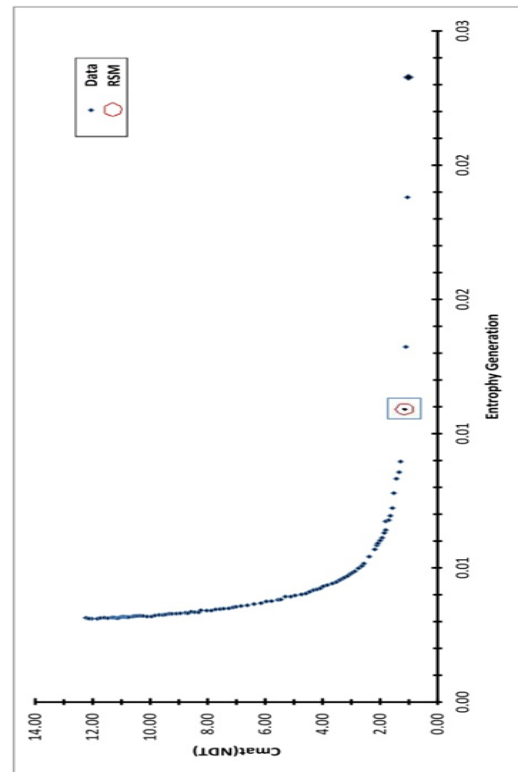

Fig. 6. RSM results for flow-through system

In Fig. 6, RSM results for the flow-through system are presented. The obtained values of 0.012 and 1.5 are for entropy generation and price function, respectively. In Fig. 7, optimization points are shown using different decision-making methods. This figure is expressed for flow-through systems and all the methods show the same point. The obtained points using the said methods in Fig. 7 are all similar and equal to 1.15 and 0.014 for price and

entropy generation, respectively. In this figure, the optimal points obtained by the decision-making methods are 0.028 for entropy generation and around 1 for price function. Fig. 6, which represents the optimized values of these functions, shows the values of 0.01 and 1 for entropy generation and price, respectively, using RSM method. Table 1 represents the optimization results of this problem using different methods.

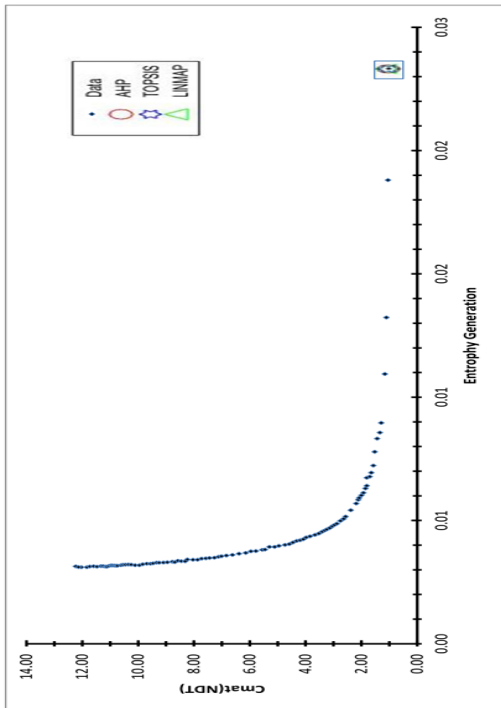

Fig. 7. Comparison of the results obtained from multi-variable methods for multi-objective flow-through system

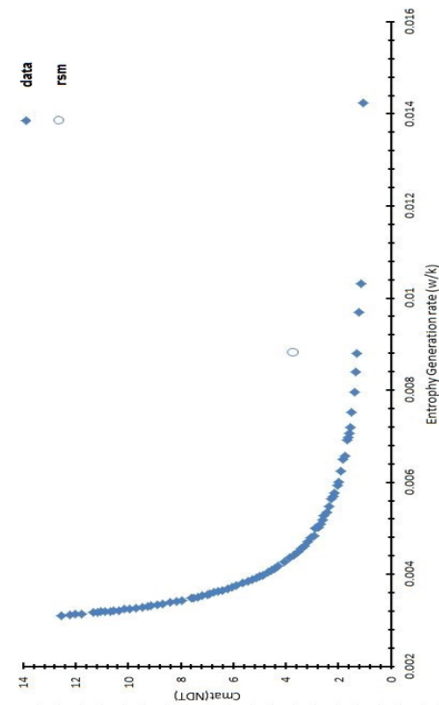

Fig. 8. RSM results for impingement flow system

The optimized results for the impingement flow are shown in Fig. 8, which are equal to 0.009 and 4 for entropy generation and price, respectively.

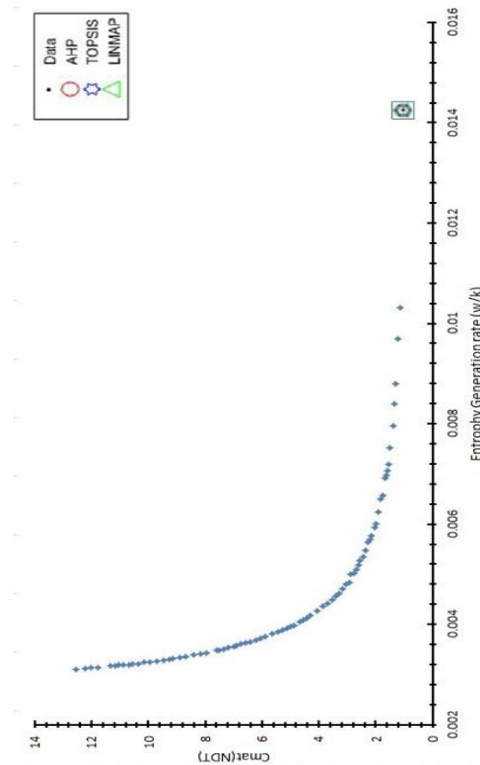

Fig. 9. Comparison of the results obtained from multi-variable methods for impingement flow system

Besides, results of the impingement flow system are shown in Figs 8 and 9.

Table 1. represents the optimization results of this problem using different methods

Method	C_{mat}	S_{gen}	N	H	b	V_f
AHP	1.1201	0.014249 W/K	2.3356	0.040988m	0.0002853m	0.6283 m/s
Topsis	1.1201	0.014249 W/K	2.3356	0.040988m	0.0002853m	0.6283 m/s
Linmap	1.1201	0.014249 W/K	2.3356	0.040988m	0.0002853m	0.6283 m/s
RSM	3.7275	0.008794 1W/K	2.0837	0.025003	0.0002007	0.50003

In the impingement flow system, the optimized points have overlapped using decision-making techniques, and a value of 0.014 indicates the optimal point for entropy generation.

6- Conclusion

Heat sink is part of a thermal convertor that cools the convertor by dissipation of heat into the surrounding air. Application of plate fin heat sinks is one of the simplest and most effective methods for cooling of electronic equipment and flow combiners. Inside this system, there exist air coolant fans so as to dissipate the generated air in the piece. Otherwise, the piece is overheated and seriously damaged. Therefore, optimal design of the heat sink is of great importance and different contributing factors have been studied. According to the diagrams, at the entropy generations over 0.01 W/k, the cost approximately does not decrease. This well indicates that entropy regulation is needed only to some extent, facilitating the optimization of both entropy and price simultaneously. In this paper, effect of variations in the number of fins and air flow velocity on the objective variables involving the materials cost and entropy generation has been investigated. Using the corresponding variables, the degree of effectiveness of each variable on the system has been explored and qualitatively shown. In general, the number of fins and air flow velocity are linearly related to the increase in the cost, while they are nonlinearly related to the decrease in entropy generation with the upward concaveness of the diagram.

References

- 1- Bejan, A. and J. Kestin, Entropy generation through heat and fluid flow. *Journal of Applied Mechanics*, 1983. **50**: p. 475.
- 2- Bejan, A., Entropy generation minimization: the method of thermodynamic optimization of finite-size systems and finite-time processes. 1995: CRC press.
- 3- Ryu, J., D. Choi, and S. Kim, Numerical optimization of the thermal performance of a microchannel heat sink. *International Journal of Heat and Mass Transfer*, 2002. **45**(13): p. 2823-2827.
- 4- Bar-Cohen, A. and M. Iyengar, Least-energy optimization of air-cooled heat sinks for sustainable development. *IEEE Transactions on Components and Packaging Technologies*, 2003. **26**(1): p. 16-25.
- 5- Shih, C. and G. Liu, Optimal design methodology of plate-fin heat sinks for electronic cooling using entropy generation strategy. *IEEE Transactions on Components and Packaging Technologies*, 2004. **27**(3): p. 551-559.
- 6- Park, K. and S. Moon, Optimal design of heat exchangers using the progressive quadratic response surface model. *International Journal of Heat and Mass Transfer*, 2005. **48**(11): p. 2126-2139.
- 7- Chiang, K.-T., F.-P. Chang, and T.-C. Tsai, Optimum design parameters of Pin-Fin heat sink using the grey-fuzzy logic based on the orthogonal arrays. *International communications in heat and mass transfer*, 2006. **33**(6): p. 744-752.
- 8- Srisomporn, S. and S. Bureerat, Geometrical design of plate-fin heat sinks using hybridization of MOEA and RSM. *IEEE Transactions on components and packaging technologies*, 2008. **31**(2): p. 351-360.
- 9- Bureerat, S. and S. Srisomporn, Optimum plate-fin heat sinks by using a multi-objective evolutionary algorithm. *Engineering Optimization*, 2010. **42**(4): p. 305-323.
- 10- Chen, C.-T. and H.-I. Chen, Multi-objective optimization design of plate-fin heat sinks using a direction-based genetic algorithm. *Journal of the Taiwan Institute of chemical Engineers*, 2013. **44**(2): p. 257-265.
- 11- Chen, C.-T. and S.-H. Jan, Dynamic simulation, optimal design and control of pin-fin heat sink processes. *Journal of the Taiwan Institute of Chemical Engineers*, 2012. **43**(1): p. 77-88.
- 12- Konstantinidis, A., et al. Multi-objective mobile agent-based sensor network routing using MOEA/D. in *IEEE Congress on Evolutionary Computation*. 2010. IEEE.
- 13- Culham, J.R. and Y.S. Muzychka, Optimization of plate fin heat sinks using entropy generation minimization. *IEEE Transactions on Components and Packaging Technologies*, 2001. **24**(2): p. 159-165.