



COP/exergy analysis of a heat pump coupled with scroll compressor systems at different wintry ambient temperatures

Mahdi Norouzi^{1,*}, M.ohsen Ghazikhani²

^{1,*} Assistant Professor, Department of Mechanical Engineering, Larestan University, Lar, Iran.

² Professor, Department of Mechanical Engineering, School of Engineering, Ferdowsi University of Mashhad, Mashhad, Iran.

Received: 15 Sep 2024

Accepted: 30 Nov 2024

Abstract

In this work, the COP/exergy analysis of a Heat Pump System Coupled with a Scroll Compressor (HPSCSC) is investigated. The experimental data was used to analyse the energy/exergy of HPSCSC at different Relative Intermediate Pressure (RIP) and wintry temperature to make clear the optimum operating condition based on more COP and extra capability. Moreover, an Energy Input Capacity (EIC) was defined to suggest the optimum operating of the system. The investigation of irreversibility in the components of the heat pump shows that the most important losses are generated in the Compressor (65-80%) and the condenser (12-15%). Also, the results confirm that even at very low ambient temperatures (-15°C) -where the COP drops-, the use of less RIP leads to an acceptable EIC and improvement in COP. The results further indicated that when the RIP exceeds 1.2, the energy transfer from the condenser remains relatively constant across various winery temperatures. Furthermore, in this study, a relation for the optimum RIP against wintry ambient temperature for an acceptable EIC and higher COP has been presented, which falls between 1.1 and 1.5.

*Corresponding author Email: norozi347@yahoo.com

Keywords: heat pump coupled with scroll compressor systems, wintry ambient temperatures, exergy analysis, COP, Relative Intermediate Pressure

1. Introduction

Heating represents an important fraction of modern society's energy needs. Nearly half of world energy consumption was consumed by heat in 2018. The heat consumed 46 % of the building space and water [1]. Heat pumps are a natural choice for heating applications as they can improve the overall energy utilization efficiency and are environmentally friendly with comparatively lower costs.

Cite this article as: M. Norouzi¹, M. Ghazikhani, COP/exergy analysis of a heat pump coupled with scroll compressor systems at different wintry ambient temperatures. Journal of Energy Conversion, 2024, 11(3), 79-93.

Approximately, one third of all single-family homes built in the US were heated by heat pumps in 1984. Heat pump systems offer economical alternatives of recovering heat from different sources for use in various industrial, commercial and residential applications. The heat pump becomes a key component in an energy recovery system with great potential for energy saving [2,3]. With economic development and improved living standards, people now want more comfortable environments which stimulate the development of new types of heat pump. Air-source heat pump (ASHP), which absorbs heat from the surrounding atmosphere, is more convenient than other heat pump systems. So, they are widely used for residential heating. However, in the past, ASHP applications have been limited to temperate zones and these type of heat pumps cannot operate efficiently and steadily for long periods during the winter in cold regions without improvements since their heating capacity decreases sharply as the outdoor temperature falls, thus in extremely cold climates -where the most heat is needed- heat pumps are least able to supply enough heat and the compressor discharge pressure and consequently discharge temperature should be increased as the ambient temperature decreases [4].

The problems that the heat pump has in operating in cold regions are low efficiency and such a great reduction in heating capacity that it cannot satisfy the heating requirement. Therefore, it is important to extend the operating conditions to relatively low ambient temperature, while maintaining, or even improving, the efficiency and reliability, and to minimize the reduction in heating capacity of the heat pump [5]. To attain the above objective, many significant efforts and investigations have been made. Zogg [6] and Ma [7] showed that the key to efficient and steady operation of a heat pump under the conditions of large temperature differences is to improve the compression process, the only energy consuming process in the heat pump system. With the aid of comprehensive analysis and comparison among the various projects to optimize the compression process, they concluded that the heat pump system with economizer coupled with the scroll compressor is the only approach with broad applicability and commercial prospects.

The heat pump system with a sub-cooler coupled with a scroll compressor has already been studied in detail with a prototype developed for heating in cold regions by Ma and Chai et al. [8,9]. Their tests show that the prototype can work smoothly and produce sufficient heat to satisfy heating requirements at ambient temperatures as low as -15°C . A code has been developed by Bell et al. [10], which aims at investigating the effect of vapor injection in scroll compressors for cold climate heat pumps. With one and two injection lines, they demonstrate an improvement in the efficiency of heating modes for cold conditions. Ma et al. have since developed a heat pump prototype with economizer coupled with a scroll compressor, and the performance characteristics of the prototype were experimentally investigated. The experimental results demonstrate that the prototype can realize a high temperature water supply and high capacity even under the low ambient temperature of -10°C to -15°C and can be used for winter heating in cold regions such as North China and the Yellow River basin [8,11]. Ma and Chai analyzed the thermodynamic cycle of the heat pump prototype and the influences of the main design parameters on the heat pump performances based on the first law of thermodynamics and the design parameters were optimized [5].

Energy analysis is commonly used for the analysis of energy systems because of its simplicity. However, it fails to reveal some kinds of loss because it only considers the quantity of energy. The quality of energy is also very important in this area. In winter, room temperature needs to be maintained at only about 20°C , so the energy quality of the heating load is low. In order to detect true losses in heating and cooling systems and make improvement, exergy analysis for whole energy chains -from primary energy source, via buildings, to sinks (i.e. the ambient environment)- has been applied [12]. Exergetic analysis based on the second law of thermodynamics can be used to evaluate the distribution of energy losses from the viewpoint of energy quality so that measures and priorities with improvement potential can be developed. An energy and exergy analysis for a novel high-temperature heat pump with scroll compressor for waste heat recovery was proposed. This system could save 57.3% of emissions compared with conventional boiler [13]. Ma and Li analyzed exergetically an essential design parameter in heat pump systems with economizer coupled with scroll compressor. They focused on optimization of the intermediate pressure, namely the working pressure of the refrigerant in the economizer, which is an essential design parameter

that affects crucially the performances of this heat pump system and found the optimal relative intermediate pressure (RIP) [5].

Over the past three years, various studies have been conducted on the energy and exergy analysis of heat pumps equipped with different peripheral components [14-18]. Additionally, in 2022, Byrne [19] conducted a thorough and systematic review focused on the modeling and simulation of heat pumps designed for simultaneous heating and cooling in buildings.

In this paper, exergy/COP analysis was used to evaluate the condition of the optimum RIP of heat transfer from the condenser and best possible of the COP at different wintry ambient temperatures of the HPSCSC.

2. Heat pump system with economizer coupled with scroll compressor

The essential component for a heat pump with economizer is a compressor with supplementary inlet(s), and screw and scroll compressors. The scroll compressor, which is a new type of displacement compressor developed successfully in the 1980s [5,20]. Fig. 1 shows a schematic of a scroll compressor. The scroll compressor is not only a positive displacement type, but the higher efficiency, small size and lower noise emission are the other advantages of this type of compressor. Moreover, the scroll compressor comprises two arrival inlets which make it quite suitable for the heat pump with economizer system.

The heat pump system with economizer coupled with scroll compressor is shown in Fig.1. In the system superheated refrigerant is discharged by the scroll compressor in high temperature and pressure (state 3) that flows through the condenser in which it usually discards energy to a cooling medium and becomes a sub-cooled liquid (state 4). Then, the sub-cooled refrigerant, from the condenser, is separated into two sections: one of the sections (state 4) flows through the expansion valve A, and the flow pressure drops to a middle pressure, which is higher than the suction pressure and lowers than the discharge pressure of the compressor. This section flow of the refrigerant passes through the expansion valve A and the pressure falls, the refrigerant expands and partly vaporizes (state 4') and then follows through the economizer, the economizer absorbs heat from the refrigerant. After the economizer, this part of refrigerant flow vaporizes completely and then enters the extra inlets of the compressor (state 6). This path is also called the supplementary or intermediate circuit. The second section of refrigerant is further sub-cooled through the economizer (state 5) and then flows through the expansion valve B (state 5'). This part of refrigerant flows into the evaporator in which it take up heat from the ambient and vaporizes fully. The vapor refrigerant from the evaporator (state 1) is sucked by the compressor, and this path is also called the main circuit. In conclusion, the two section of refrigerant are compressed to state 2 by the scroll compressor. It should be noted that the solenoid valve regulates the mass flow rate of supplementary circuit [5].

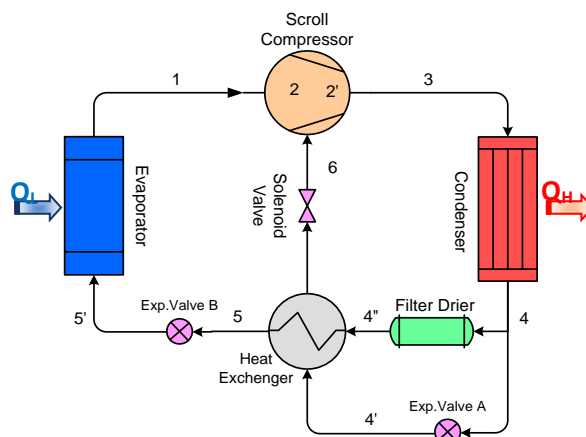

Figure 1. Heat pump system with economizer.

Table 1. Shows the experimental data of the heap pump system with the economizer coupled with the scroll compressor has been developed by Ma [5]. In this paper, our analysis are based on this experimental data.

Table1. Experimental data for the heat pump system with scroll compressor [5].

t1	P1	t3	P3	t4	P4	t4'	t4''	P4''	t5	P5'	t6	P6	W _{comp}	Q _{cond}	Q _{eva}
°C	Bar	°C	bar	°C	bar	°C	°C	bar	°C	bar	°C	Bar	kW	kW	kW
-22.58	2.118	128.7	17.016	42.8	16.699	23.28	43.07	16.621	42.54	2.181	16.83	6.313	3.23	5.369	2.536
-22.87	2.105	122.7	17.038	42.78	16.67	23.33	43.1	16.596	42.56	2.162	20.33	7.617	3.33	5.482	2.516
-23.01	2.111	119.4	17.027	42.55	16.613	24.22	42.87	16.544	42.33	2.171	23.53	8.782	3.41	5.583	2.525
-22.82	2.124	115.7	17.018	42.31	16.549	24.12	42.58	16.483	42.09	2.185	26.77	10.137	3.47	5.636	2.677
-21.65	2.116	113.3	17.054	42.38	16.547	24.82	42.53	16.487	42.09	2.177	29.27	11.151	3.55	5.651	2.538
-22.84	2.093	112.6	17.057	42.43	16.524	28.37	42.47	16.464	42.07	2.153	31.06	11.915	3.59	5.711	2.484
-14.89	2.466	126.5	17.069	43.03	16.756	21.95	43.15	16.66	42.82	2.532	13.78	5.303	3.16	5.687	2.844
-15.76	2.427	122.4	17.018	42.87	16.665	23.16	43	16.575	42.68	2.493	17.23	6.385	3.24	5.745	2.873
-14.38	2.466	116.9	17.021	42.68	16.606	23.08	42.78	16.524	42.5	2.535	20.39	7.559	3.31	5.865	2.886
-14.65	2.458	114.6	17.112	42.81	16.661	22.79	42.94	16.577	42.64	2.527	22.72	8.43	3.35	5.905	3.023
-14.63	2.445	111.5	17.059	42.6	16.552	23.06	42.68	16.476	42.39	2.515	26.02	9.763	3.42	5.921	2.847
-14.14	2.454	108.5	17.011	42.35	16.437	23.12	42.39	16.364	42.17	2.526	29.3	11.192	3.475	5.925	2.799
-13.82	2.454	106.4	16.996	42.17	16.368	22.67	42.26	16.299	42	2.528	31.45	12.19	3.515	5.964	2.893
-13.98	2.447	105.4	17.117	42.44	16.465	25.32	42.45	16.4	42.24	2.519	33.53	13.011	3.55	5.993	2.719
-9.35	2.948	115.1	17.064	42.88	16.69	24.99	43.12	16.595	42.76	3.042	13.53	5.094	3.06	7.001	4.173
-9.03	2.958	111.4	17.007	42.59	16.592	24.79	42.9	16.562	42.47	3.053	16.38	6.113	3.121	7.239	3.642
-9.19	2.933	108.4	17.004	42.45	16.542	24.16	42.64	16.459	42.26	3.03	19.36	7.225	3.2	7.353	4.134
-9.14	2.944	105	17.035	42.42	16.498	24.44	42.5	16.418	42.2	3.038	23.37	8.724	3.27	7.366	4.205
-9.1	2.938	101.6	17.023	42.22	16.399	24.26	42.31	16.32	42	3.034	26.95	10.219	3.34	7.428	4.125
-8.47	2.95	99	17.086	42.23	16.363	24.57	42.32	16.285	42	3.049	31.25	12.067	3.42	7.423	3.92
-8.02	2.963	98	17.001	41.94	16.218	29.1	41.98	16.144	41.7	3.062	33.61	13.08	3.45	7.428	3.758

3. Thermodynamic analysis for heat pump system

3.1. Total Irreversibility

The quantity of work capacity of a system destroyed or lost during a process is defined as the irreversibility of the process. The irreversibility is also known as the lost work. For calculating the total irreversibility, the irreversibility associated with heat transfer should be considered for the control volume. So based on exergy balance equation, it could be calculated by equation (1):

$$I_{tot}^o = \sum Q_j^o \left(1 - \frac{T_o}{T_j}\right) + \sum m_i^o (h_i - T_o s_i) - \sum m_e^o (h_e - T_o s_e) + W_{act}^o \quad (1)$$

Where Q_j^o represents the heat transfer rate to or from heat reservoirs at T_j . In the heat pump system with economizer coupled with scroll compressor the internal irreversibility of system can be deliberated by summation of total irreversibility of the components in this system as follow:

$$I_{tot}^o = I_{tot.comp}^o + I_{tot.cond}^o + I_{tot.eva}^o + I_{tot.Exp-A}^o + I_{tot.Exp-B}^o + I_{tot.eco}^o + I_{tot.fd}^o \quad (2)$$

Where $I_{comp}^o, I_{cond}^o, I_{eva}^o, I_{Exp-A}^o, I_{Exp-B}^o, I_{eco}^o, I_{fd}^o$ is the total irreversibility in the scroll compressor with economizer inlets, condenser, evaporator, expansion valve A, expansion valve B, economizer, filter dryer, respectively.

3.1.1 Total irreversibility in each component

For the calculation of the total irreversibility of compressor base on Eq. (1), the atmospheric temperature as a heat reservoir is equal to ambient temperature ($T_j = T_o$), so we have

$$\sum Q_j^o(1 - T_o/T_j) = 0 \text{ and total irreversibility of compressor base on Eq. (1) would be:}$$

$$I_{tot.comp}^o = \sum m_i^o(h_i - T_o s_i) - \sum m_e^o(h_e - T_o s_e) + W_{comp}^o = E_{in} - E_{out} + W_{comp}^o \tag{3}$$

In the condenser of system, reservoir is room and T_j in Eq. 1 is equal to room temperature. So the total irreversibility of condenser can be written as:

$$I_{tot.cond}^o = \sum Q_j^o(1 - \frac{T_o}{T_r}) + \sum m_i^o(h_i - T_o s_i) - \sum m_e^o(h_e - T_o s_e) \tag{4}$$

Where T_o is the ambient temperature and T_r is the room temperature.

In evaporator of system, reservoir is ambient and T_j in Eq. 1 is equal to ambient temperature. So the total irreversibility of condenser can be written as:

$$I_{eva-tot}^o = \sum Q_j^o(\frac{T_o}{T_o} - 1) + \sum m_i^o(h_i - T_o s_i) - \sum m_e^o(h_e - T_o s_e)$$

$$= \sum m_i^o(h_i - T_o s_i) - \sum m_e^o(h_e - T_o s_e) \tag{5}$$

Where T_o is the ambient temperature. Table.2 shows the simplified equations (1) for each component of the system.

Table.2 irreversibility of components of heat pump system.

Components	Total and internal irreversibility
Compressor	$I_{comp-tot}^o = m_1^o(h_1 - T_o s_1) + m_6^o(h_6 - T_o s_6) - m_3^o(h_3 - T_o s_3) + W_{act}^o$
Condenser	$I_{cond-tot}^o = \sum Q_j^o(1 - \frac{T_o}{T_r}) + \sum m_3^o(h_3 - T_o s_3) - \sum m_4^o(h_4 - T_o s_4)$
Evaporator	$I_{eva-tot}^o = m_1^o(h_5 - T_o s_5) - m_1^o(h_1 - T_o s_1)$
Expansion valve B	$I_{Exp-B-tot}^o = m_1^o T_o (s_5 - s_5)$
Economizer	$I_{eco-tot}^o = m_5^o(h_4'' - T_o s_4'') - m_5^o(h_5 - T_o s_5) + m_6^o(h_4' - T_o s_4') - m_6^o(h_6 - T_o s_6)$
Expansion valve A	$I_{Exp-A-tot}^o = m_6^o T_o (s_4' - s_4)$
Filter dryer	$I_{fd-tot}^o = m_1^o [(h_4 - T_o s_4) - (h_4'' - T_o s_4'')]$

3.2. Exergy input

The electrical power consumed in the components of the heat pump is equal to the rate of exergy input of system, which can be expressed as:

$$\dot{E} x_{in} = P \tag{6}$$

Where P is the electrical power of the heat pump system. The compressor consumes more than 95% of the total energy consumed. Other components, such as the fan, solenoid valve, etc., put away only 5% of energy. Therefore, the electric power of the compressor is approximately considered as a rate of exergy input in this work.

3.3. Exergy output

The rate of exergy flow associated with the heating capacity in the condenser considered as the rate of exergy output of the heat pump system. It can be expressed as:

$$\dot{E}x_{out} = \dot{Q}_{cond} \left(1 - \frac{T_o}{T_r}\right) \quad (7)$$

Where \dot{Q}_{cond} is the heating capacity of the condenser.

3.4. Second-law effectiveness

The second-law effectiveness (ε) can be explained as a performance parameter for a process based on availability concepts. It can be expressed as [16]:

$$\varepsilon = \frac{\dot{E}x_{out}}{\dot{E}x_{in}} = \frac{\dot{Q}_{cond} \left(1 - \frac{T_o}{T_r}\right)}{P} = \frac{\dot{Q}_{cond}/P}{1/\left(1 - \frac{T_o}{T_r}\right)} = \frac{COP_{act}}{COP_{carnot}} \quad (8)$$

3.5. Relative intermediate pressure

The theoretical optimum intermediate pressure for a two-stage compressor is equal to the geometric mean of the suction and discharge pressure of the compressor [5]. The relative intermediate pressure (RIP) is defined as the ratio of the intermediate pressure to the optimum intermediate pressure:

$$RIP = \frac{p_i}{(p_d p_s)^{0.5}} \quad (9)$$

Where p_i is the intermediate pressure [8].

3.6. Energy Dissipation Rate

The Energy Dissipation Rate (EDR) expresses the amount of the energy needs to heating of the space. On the other hand, EDR is the energy requirement to retain the temperature of the space in a constant value [17]. The EDR in this research is calculated for a space of 2.25m * 2m * 3m.

3.7. Energy Input Capacity

The Energy Input Capacity (EIC) is defined as a ratio of energy transfer rate from a condenser in a heat pump system to the energy dissipation rate. The amount of this parameter should be more than one for an appropriate selecting of a heat pump to heat a room with a reasonable cut off energy consuming period.

$$EIC = \frac{\text{Energy Transfer Rate (ETR)}}{\text{Energy Dissipation Rate (EDR)}} \quad (10)$$

4. Results and Discussion

The rate of exergy input, that is equal to the electrical power to the heat pump, varies with RIP as shown in Fig.2 The rate of exergy input increases with increasing of RIP linearly. As shown in Fig.5, the variation of the ambient temperature (which is equal to evaporation temperature minus $10^\circ C$) has a poor effect on the rate of exergy input. As Fig.2 shows decreasing in the ambient temperature, has not significant effect on increasing of the rate of exergy input. It is due to this fact that in the lower ambient temperature the mass flow rate of the refrigerant passing through main cycle decreases and the mass flow rate of secondary cycle increases so the variation of ambient temperature has no significant effect on the electrical power.

The rate of total irreversibility of the heat pump system varies with RIP as shown in Fig. 3 when the condensation temperature is set at nearly 45°C . The rate of total irreversibility becomes larger with an increase in RIP. This is due to importance of the temperature difference of intermediate and main circuit arriving to the scroll compressor. The temperature difference arriving to the scroll compressor usually exists in all operation conditions, when the RIP increases the difference of the potential of irreversibility through the compressor promoted and as a result the total irreversibility increases as Fig. 3 announced. The figure also indicates that not only there is a similar slop of irreversibility for different wintry ambient temperature, but in the case of the possibility of using the lower RIP the amount of total irreversibility of the system is marginally reduced. In the next sections this is one of the important indications for the optimum operation condition.

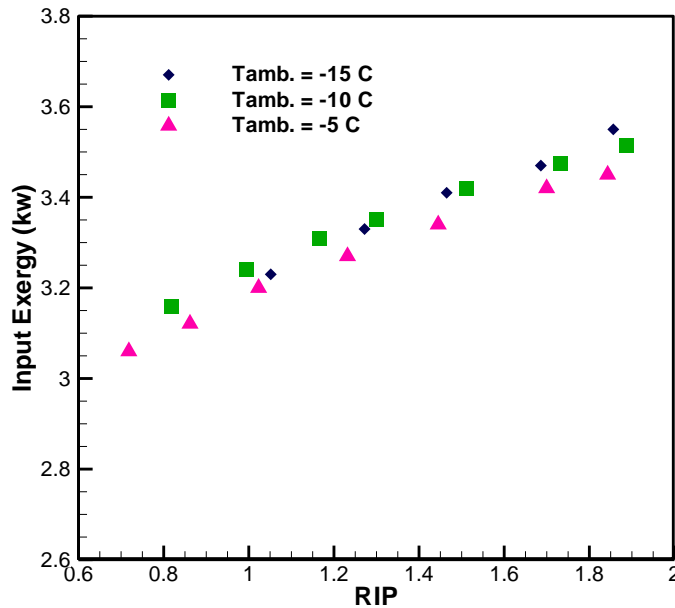

Fig.2 Variation of the rate of exergy input, as given in with the RIP.

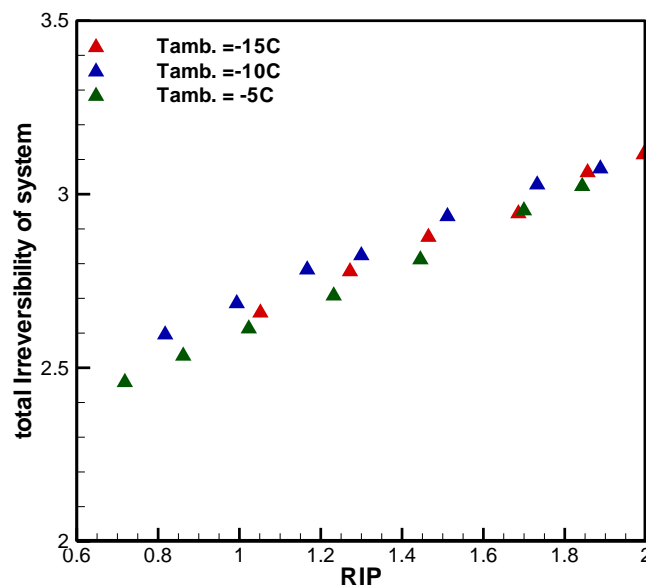
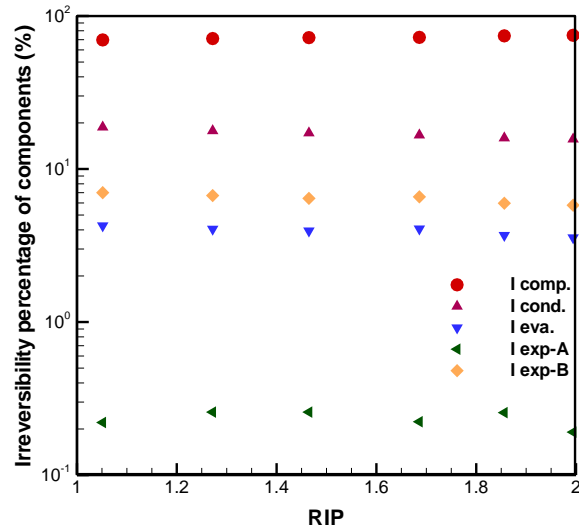
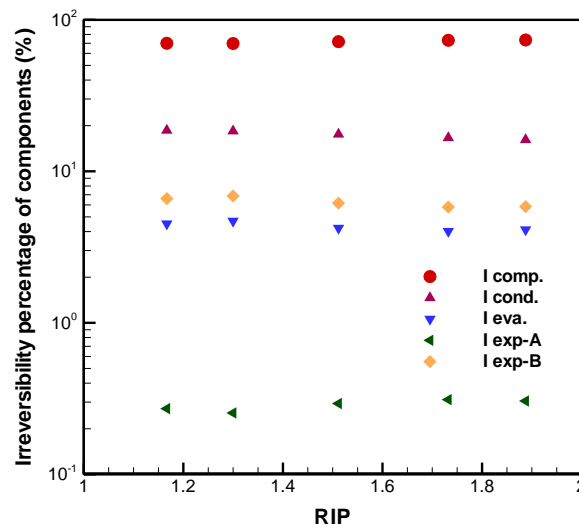

Fig. 3 Variation of the total irreversibility created of the heat pump system with the RIP at various ambient temperatures.

The variations of the percentage of total irreversibility of the components of the heat pump against the RIP at three wintry ambient temperatures are shown in Fig.4. The maximum irreversibility belongs to the compressor, the percentage of irreversibility of the condenser is less than the compressor. The irreversibilities of the expansion valve in the main circuit (expansion valve B), evaporator and expansion valve in the intermediate circuit (expansion valve A) from the point of high to low percentage value are shown in the figure respectively. It should be noted that the scroll compressor and the condenser have the main contribution of the irreversibility creation of the system.



a) $T_{amb.} = -15^{\circ} C$



b) $T_{amb.} = -10^{\circ} C$

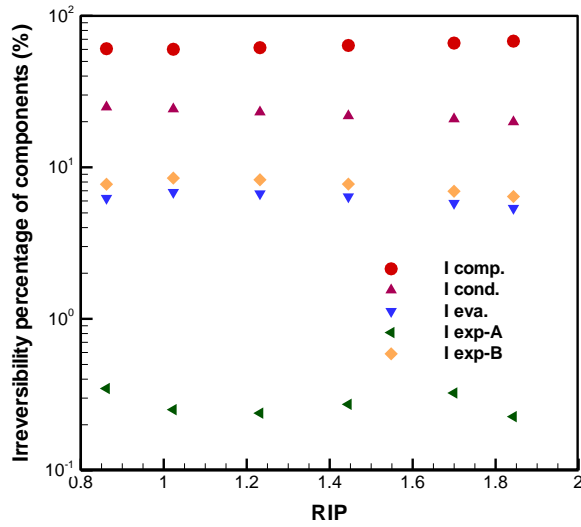

c) $T_{amb} = -5^\circ C$

Fig. 4 Percentage of the Total irreversibility created of the components of the system at various ambient temperatures.

The effectiveness of the system against the RIP is shown in Fig. 5. It can be seen that increasing in RIP reduces the effectiveness. In fact, the amount of effectiveness is equal to the ratio of actual COP to the Carnot COP. This figure reveals that the amount of RIP around one has belonged to the higher second law efficiency. Fig. 5 is also declared that the amount of RIP close to one is contributed to the lower irreversibility as Fig. 3 shown.

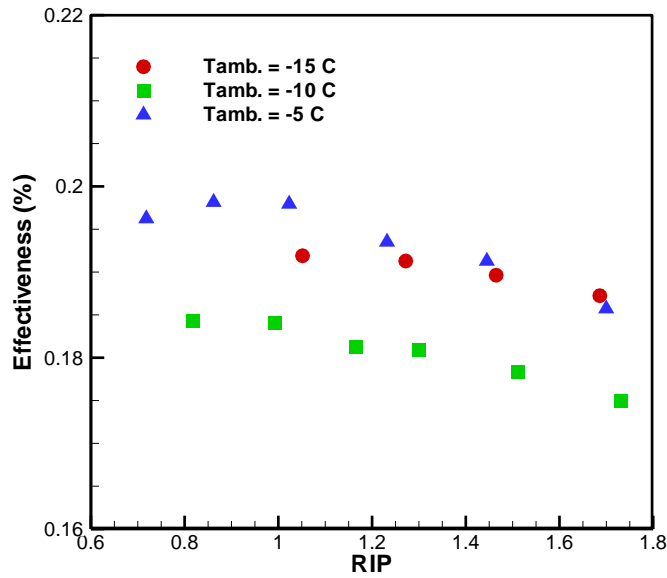

Fig. 5 Variation of effectiveness with the RIP at various ambient temperatures.

Fig. 6 shows the discharged temperature of the condenser against RIP for different wintry ambient conditions. The figure declared the independence capability of the condenser for heating process of the room at different operation and wintry conditions.

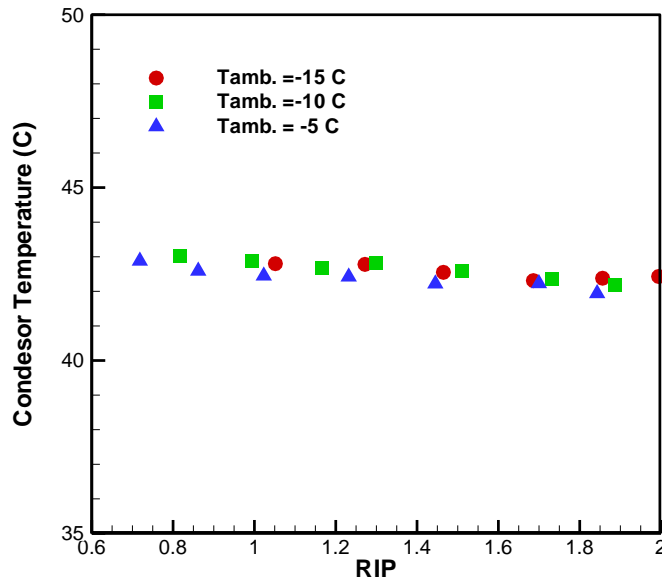

Fig. 6 Variation of the discharged condenser temperature of the system against the RIP at various ambient temperatures.

The rate of energy transfer of the condenser to the room varies with RIP is shown in Fig. 7. It can be seen that at three wintry ambient temperatures, the amount of energy transfer to the room increases with RIP. This could make a confuse conclusion; that with selecting the lower RIP the capability of energy transfer of the heat pump becomes poor.

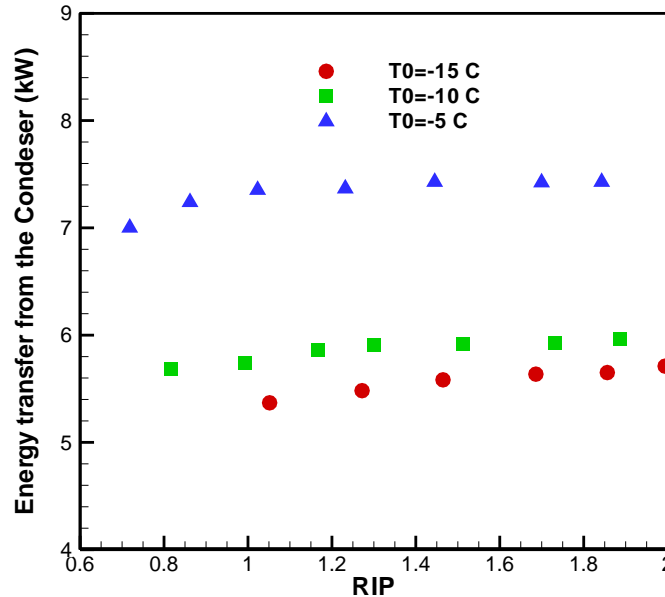

Fig. 7 Variation of the energy transfer of condenser to the room with the RIP at various ambient temperatures.

The capability of energy transfer to the room at different ambient and RIP can be interoperated with definition of EIC. Fig. 8 revealed that at higher RIP for a given wintry ambient temperature the percentage increment of EIC is from 3-5%, while it is possible for a real application to use higher heat pump capacity to improve EIC.

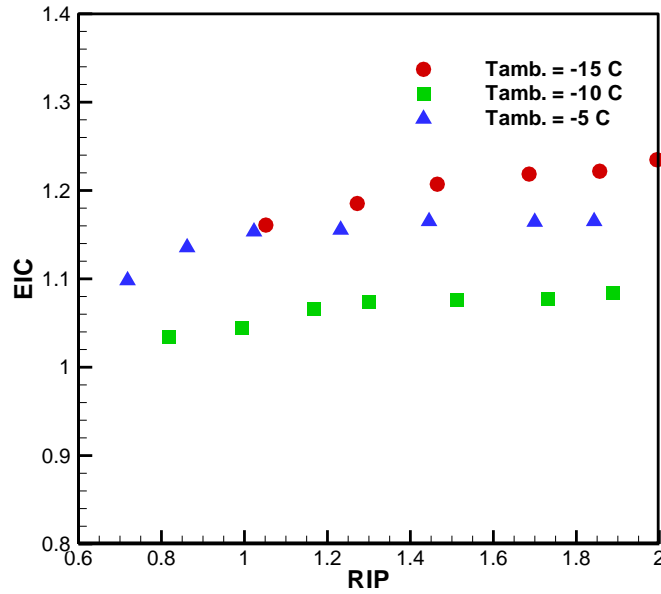

Fig. 8 Variation of EIC with the RIP at various ambient temperatures

The COP of the heat pump system varies with RIP as shown in Fig. 9. The figure shows that with increasing the RIP, COP reduces. This is confirmed with the Fig. 4 in which the cycle irreversibility increases with raising RIP. It should be noted that higher irreversibility apparent with higher work consumed in the heat pump which makes lower COP in the heat pump system. The maximum COP at three different wintry ambient temperature presented in Fig. 10. This figure shows that if we operate HPSCSC in the maximum COP, there would be a lower irreversibility as shown in Fig. 4. In addition, by this strategy, we do not have any problem in operating of the system based on EIC parameter as defined in this work, unless that we should increase the interval time of using the system in the cooler wintry ambient temperatures.

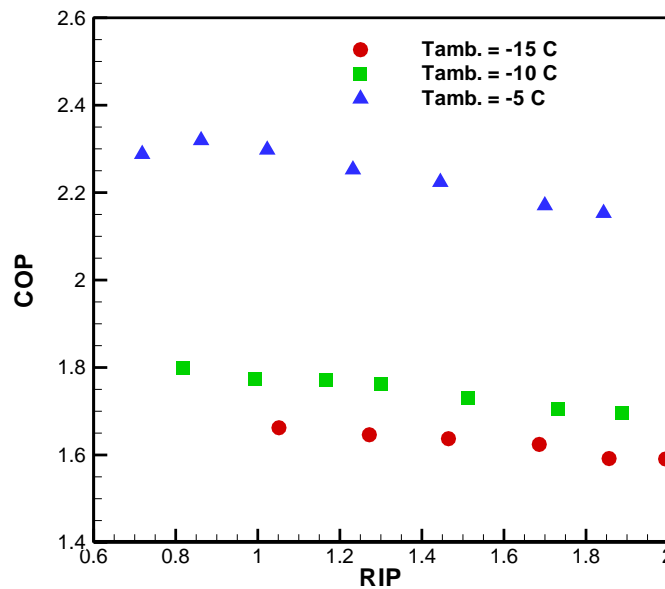

Fig. 9 Variation of COP with the RIP at various ambient temperatures.

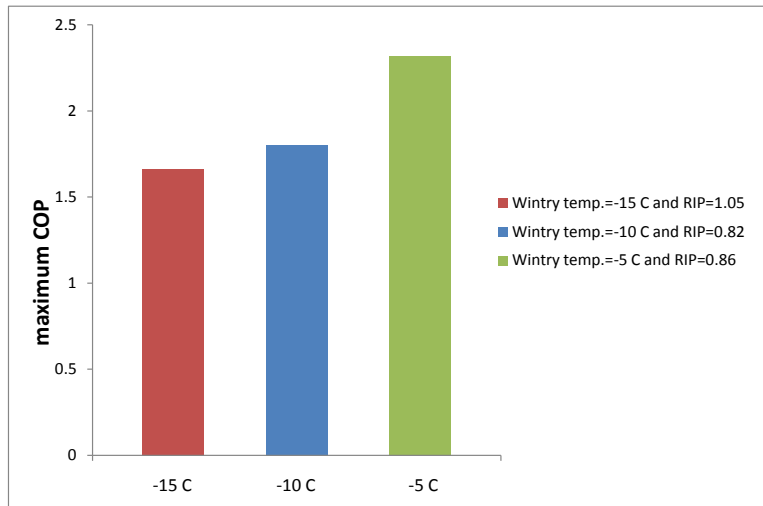

Fig. 10 Maximum COP condition of the HPSCSC at various ambient temperatures.

On the other hand, it can be seen that the increment in amount of energy transfer to the room terminates at a specific RIP, and after that, the amount of energy transfer to the room becomes constant. It means that increasing of RIP more than this specific RIP is not rational and RIP in this point is optimum. Table 3. shows this specific RIP for three wintry ambient temperatures. The optimum RIP increases with decreasing of the ambient temperature as shown in Fig.11. Relation between Optimum RIP and ambient temperature can be expressed with Eq.11 by curve fitting of the data of Table.3:

$$RIP_{opt} = 0.002 T_{amb}^2 - 1.082 T_{amb} + 147.4 \quad (11)$$

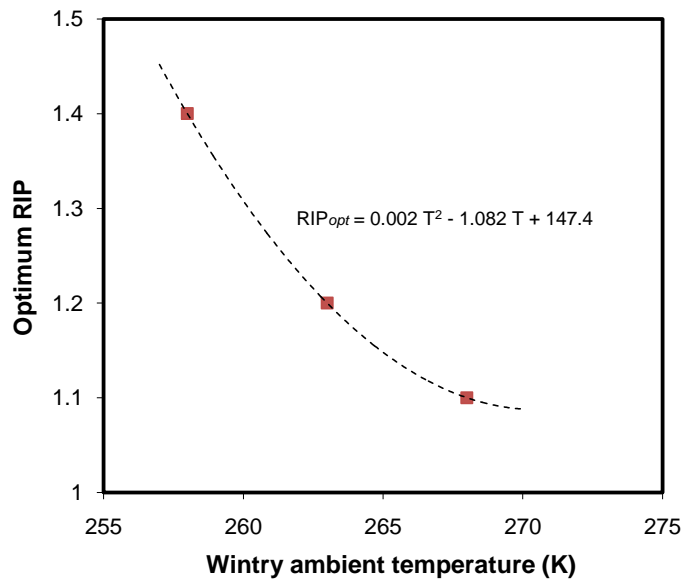

Fig. 11 Optimum RIP based on the amount of COP at different ambient temperatures.

Table. 3 The optimum RIP at three wintry ambient temperatures.

the wintry ambient temperature ($^{\circ}C$)	Optimum RIP
-5	1.1
-10	1.2
-15	1.5

5. Conclusion

In this paper, the COP/exergy optimization analysis of HPSCSC has been performed at different wintry ambient temperatures. The investigation of irreversibility in the components of the heat pump shows that the most important losses are generated in the Compressor and the percentage of total irreversibility for each component do not vary with ambient temperature. Also, the results shows that the rate of total irreversibility becomes larger with an increase in RIP linearly. In addition, with increasing the RIP, COP and effectiveness reduces. It means that higher consumed work and irreversibility, apparent in the heat pump with higher RIP. Also, the optimum RIP shows that the intermediate pressure in the scroll compressor is only 10-20 percent larger than the theoretical optimum intermediate pressure for a two-stage compressor. It results that selecting the lower RIP is more appropriate base on first and second thermodynamic law efficiencies. This conclusion justifies by definition of a new parameter as EIC.

Nomenclature		Subscripts	
ε	Second-law effectiveness	1-6	State 1 to 6
Ex	rate of exergy	act	actual
h	specific enthalpy	amb	ambient
I^o	rate of irreversibility	comp	compressor
m^o	mass flow rate	cond	condenser
P	Power	d	discharge
p	pressure	exp	expansion valve
Q^o	Heating or cooling capacity	eva	evaporator
s	specific entropy	eco	economizer
T	Temperature	e	exit
Acronyms and abbreviations		fd	filter dryer
ASHP	Air-Source Heat Pump	i	input, intermediate
COP	Coefficient Of Performance	o	output
EIC	Energy Input Capacity	opt	optimum
EDR	Energy Dissipation Rate	r	room
ETR	Energy Transfer Rate	s	suction
RIP	Relative Intermediate Pressure	tot	total
HPSCS	Heat Pump System Coupled with Scroll Compressor		

References

- [1] H. G. Ozcan, A. Hepbasli, A. Abusoglu, A. Anvari-Moghaddam, Energy, exergy, economic, environmental and sustainability (4ES) analyses of a wastewater source heat pump system for district heating applications based on real operational data, *Sustainable Energy Technologies and Assessments*, 56 (2023).
- [2] E. Elgendy, J. Schmidt, Experimental study of gas engine driven air to water heat pump in cooling mode, *Energy*, 35 (10)(2010) 2461-2467.
- [3] B. J. Dechesne, F. M. Tello-Oquendo, S. Gendebien, V. Lemort, Residential air-source heat pump with refrigerant injection and variable speed compressor: Experimental investigation and compressor modeling, *International Journal of Refrigeration*, 108(2019) 79-90.
- [4] G. Ma, H. X. Zhao, Experimental study of a heat pump system with flash-tank coupled with scroll compressor, *Energy and Buildings*, 40(5)(2008) 697-701.
- [5] G. Ma, X. Li, Exergetic optimization of a key design parameter in heat pump systems with economizer coupled with scroll compressor, *Energy Conversion and Management*, 48(4)(2007) 1150-1159.
- [6] M. Zogg, The Swiss retrofit heat pump programme, In *Proceedings of the 7th international energy agency conference on heat pumping technologies*, 1(2002) 209–18.
- [7] G. Ma, Research on adaptability of air-source heat pump under low ambient temperature, *Postdoctoral Research Report*, Tsinghua University, Beijing (2001).
- [8] G. Ma, Q. Chai, Y. Jiang, Experimental investigation of air-source heat pump for cold regions, *International Journal of Refrigeration*, 26(2003) 12–18.
- [9] Q. Chai, G. Ma, J. Xia, Thermodynamic analyses of scroll refrigeration system with economizer, *Journal of Tsinghua University*, 43(2003)1401–1404.
- [10] I.H. Bell, E.A. Groll, J.E. Braun, W.T. Horton, *Simulation of a cold climate heat pump furnished with a scroll compressor with multiple vapor injection lines*, 8th International Conference on Compressors and their Systems, Woodhead Publishing (2013).
- [11] G. Ma, Yan Q, Jiang Y. Heat pump system for air conditioning adaptable to cold regions, U.S. Patent No. US6, 481,234(2002).
- [12] J. Xiang, J. Zhao, N. Qin, Exergetic cost analysis of a space heating system, *Energy and Buildings*, 42(2010) 1987-1994.
- [13] C. Mateu-Royo, J. Navarro-Esbrí, A. Mota-Babiloni, F. Molés, M. Amat-Albuixech, Experimental exergy and energy analysis of a novel high-temperature heat pump with scroll compressor for waste heat recovery, *Applied Energy*, 253(2019).
- [14] C. Treichel, C.A. Cruickshank, Energy Analysis of Heat Pump Water Heaters Coupled with Air-Based Solar Thermal Collectors in Canada and the United States, *Energy*, 221(2021) 119801.

- [15] K. Shaker Al-Sayyab, J. Navarro-Esbrí, A. Mota-Babiloni, Energy, exergy, and environmental (3E) analysis of a compound ejector-heat pump with low GWP refrigerants for simultaneous data center cooling and district heating, *International Journal of Refrigeration*, 133(2022) 61-72,
- [16] H. Shoeibi, M. Mehrpooya, E. Assareh, M. Izadi, F. Pourfayaz, Transient Simulation and Exergy Analysis of Heat-Pump Systems Integrated with Solar Compound Parabolic Collector, *Iranian Journal of Chemistry and Chemical Engineering*, 41(6)(2022) 2121-2134.
- [17] J. Sun, J. Guo, L. He, S. Hou, Z. Yu, Comparative research on vapor injection heat pump with a novel flash tank, *Heliyon*, 9(6)(2023).
- [18] Y. Xu, J. Wang, X. Shen, Z. Sun, X. Wang, X. Han, Thermodynamic analyses and performance improvement on a novel cascade-coupling-heating heat pump system for high efficiency hot water production, *Energy Conversion and Management*, 293(2023) 117448.
- [19] P. Byrne, Research Summary and Literature Review on Modelling and Simulation of Heat Pumps for Simultaneous Heating and Cooling for Buildings, *Energies*, 15(10)(2022) 1-43.
- [20] G. Ma, Q. Chai, Characteristics of an improved heat pump cycle for cold regions, *Applied Energy*, 77(2004), 235–354.
- [21] Jr. Kenneth Wark, *Advanced thermodynamics for engineers*, McGraw-Hill (1995).
- [22] A. M. Khashab, *Heating, Ventilating, and Air-Conditioning Systems Estimating Manual*, (2nd Edition), McGraw-Hill, (1984).